

050-Fencing Type 3

1 1:25

Rev	Description	Date
1	Revision 1	26/05/10
2	For Tender	27/07/10

Scale:	1 : 25	@ A1
Drawn By:	ARH,JD	
Checked By:	MF	
Designed By:	MF	
Approved By:	MF	
Drawn Date:	26/05/2010	

Consultants:	
Civil:	Aurecon
Structural:	Aurecon
Mechanical:	Opus
Electrical:	Opus
Fire:	Opus
Security:	Opus
Communications:	Opus
Traffic:	Traffic Design Group
Landscaping:	Jerome Luiten

Project: Whangarei Mental Health Inpatient Unit
 Fitness Fleming Architects Ltd
 PO Box 78068
 Corner of Victoria Street
 Auckland
 Design shown is copyright of FFA Limited

Project: Whangarei Mental Health Inpatient Unit
 Maunu Road, Whangarei
 Northland
 New Zealand

Sheet name: **Fencing Details (Type 3)**

Discipline: ARCHITECTURE
 Status: Tender
 No. **A062** 2

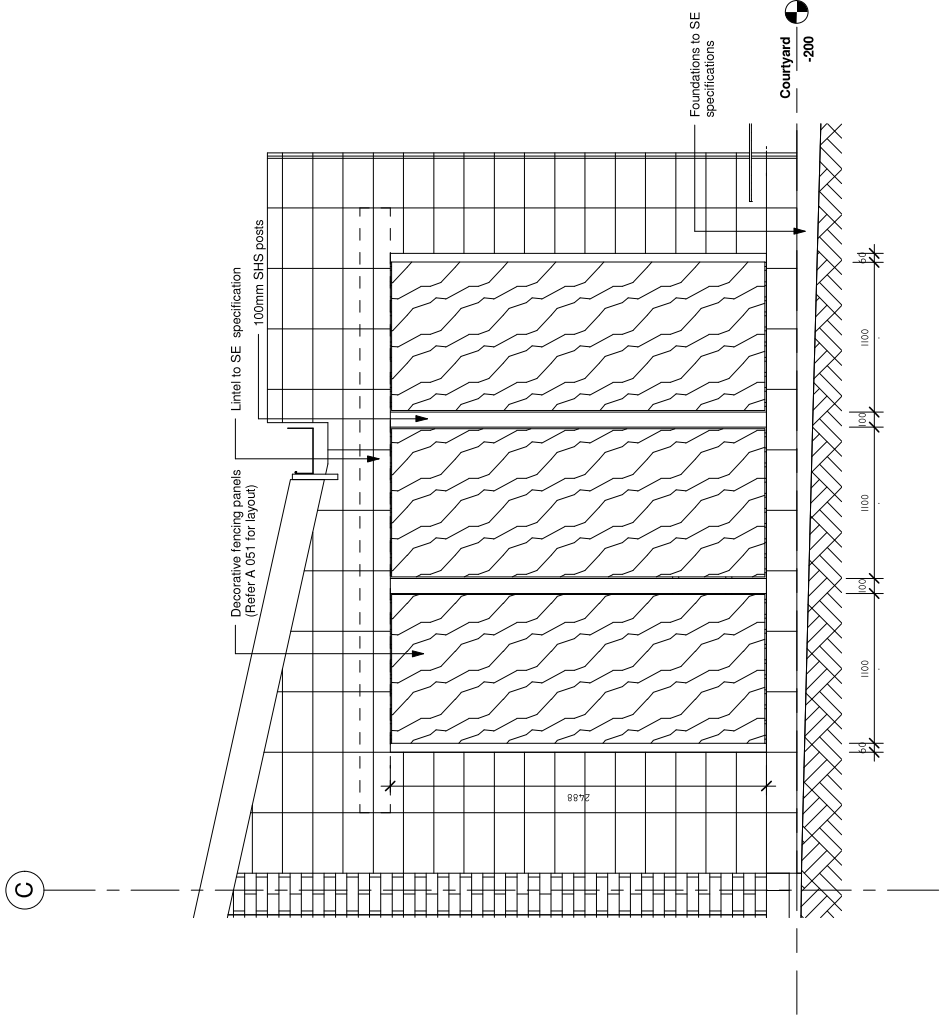

1 050-Decorative panels to front
1 : 25

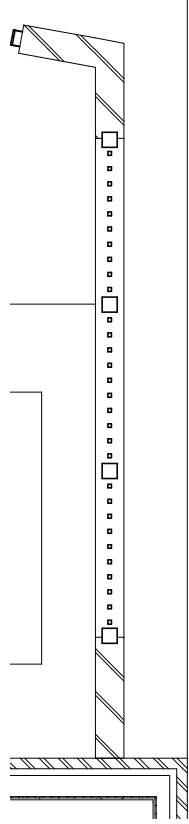

2 Site 050-Decorative panels
1 : 25

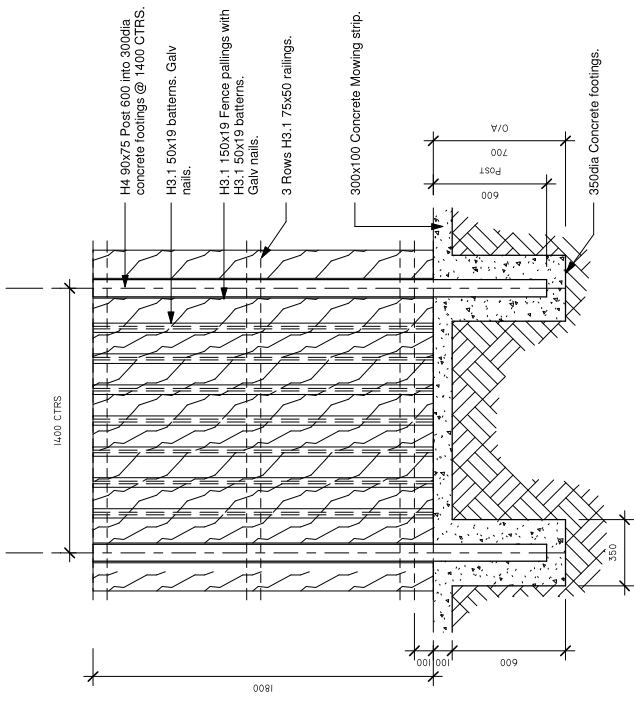

3 050-Typical Timber Fence
1 : 20

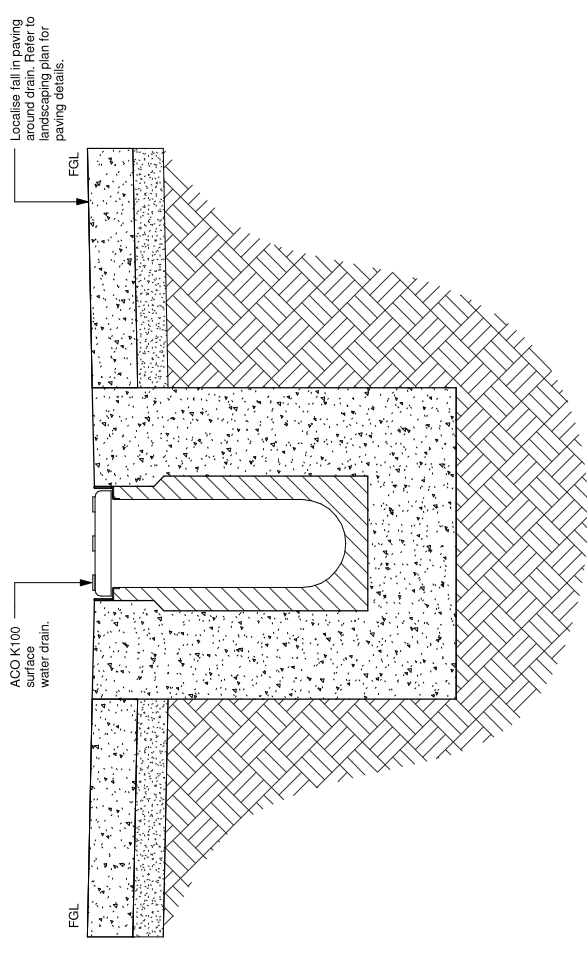

4 050-Surface Slot Drain
1 : 5

Rev	Description	Date
1	Revision 1	26.05.10
2	For Tender	27.07.10

Scale:	As indicated	@ A1
Drawn By:	ABH:JD	
Checked By:	MF	
Designed By:	MF	
Approved By:	MF	
Drawn Date:	26/05/2010	

Consultants:		
Civil:	Aurecon	Opus
Structural:	Aurecon	Opus
Mechanical:	Opus	Traffic Design Group
Electrical:	Opus	Jerome Luiten
Fire:	Opus	

Project:
Whangarei Mental Health Inpatient Unit
 Maunu Road, Whangarei
 Northland
 New Zealand

Project:
Whangarei Mental Health Inpatient Unit
 Maunu Road, Whangarei
 Northland
 New Zealand

Sheet name:
Fencing details (panels)

Discipline: ARCHITECTURE
 Status: Tender
 No. A064 2

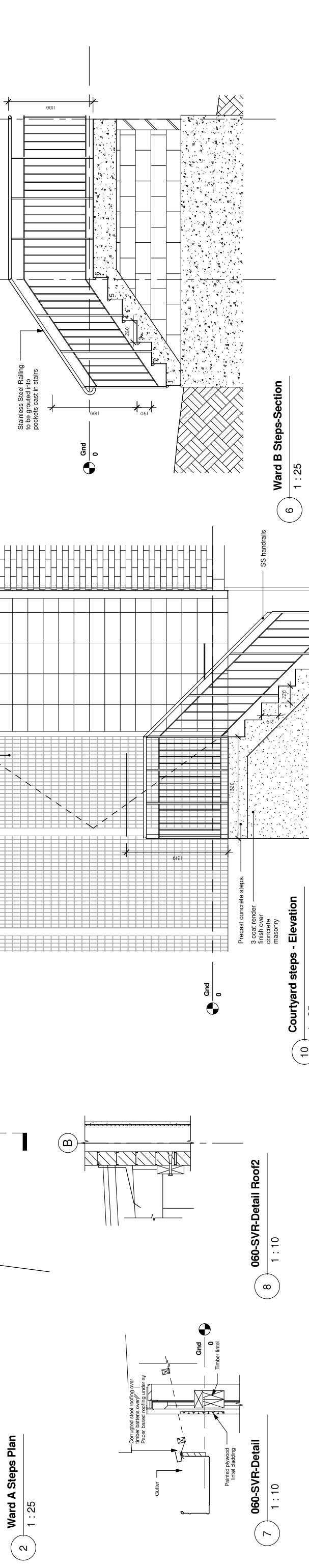
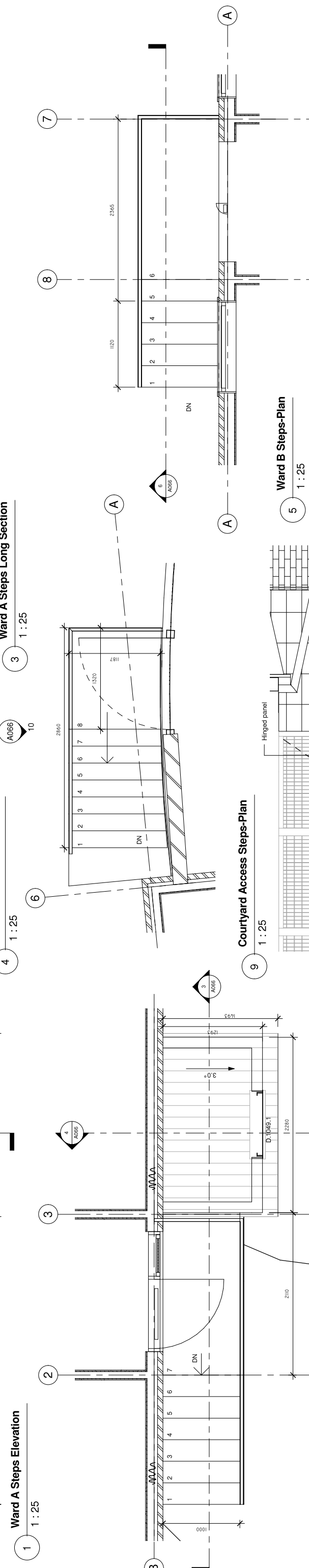
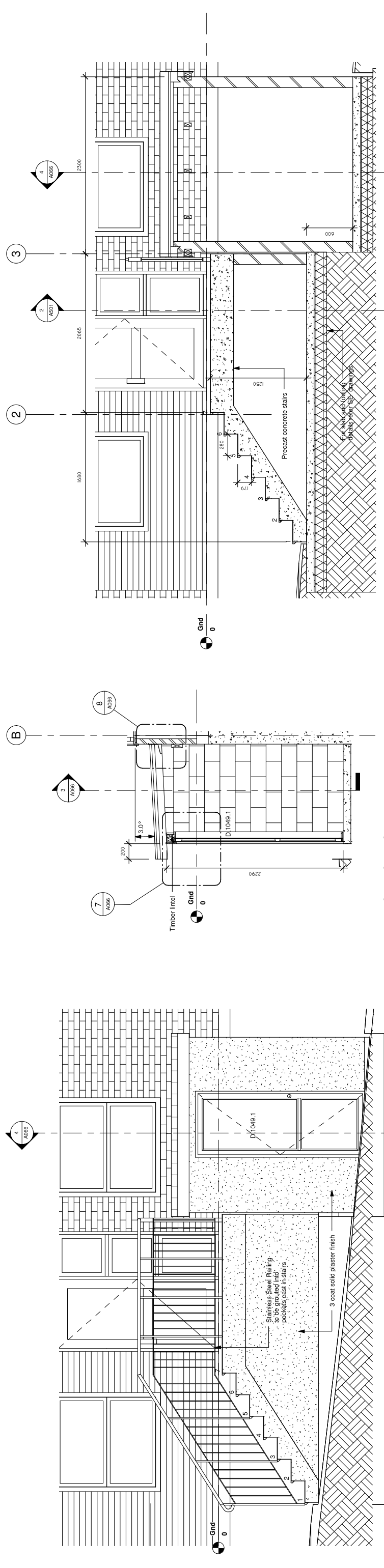

Rev	Description	Date
1	Revision 1	26.05.10
2	For Tender	27.07.10

Revision Schedule	@ A1
As indicated	

Drawn By:	Checked By:	Designed By:	Approved By:	Drawn Date:
ABH,JD	MF	MF	MF	26/05/2010

Consultants:	Opus
Civil:	Aurecon
Structural:	Aurecon
Mechanical:	Opus
Electrical:	Opus
Fire:	Opus
Security:	Opus
Communications:	Opus
Traffic:	Traffic Design Group
Landscaping:	Jerome Luiten

Revision Schedule	Date
As indicated	

Drawn By:	Checked By:	Designed By:	Approved By:	Drawn Date:
ABH,JD	MF	MF	MF	26/05/2010

Consultants:	Opus
Civil:	Aurecon
Structural:	Aurecon
Mechanical:	Opus
Electrical:	Opus
Fire:	Opus
Security:	Opus
Communications:	Opus
Traffic:	Traffic Design Group
Landscaping:	Jerome Luiten